

YAESU GS-232A

*Computer Control Interface
for Antenna Rotators*



YAESU MUSEN CO., LTD.

4-8-8 Nakameguro, Meguro-Ku, Tokyo 153-8644, Japan

YAESU U.S.A.

17210 Edwards Rd., Cerritos, CA 90703, U.S.A.

YAESU EUROPE B.V.

P.O. Box 75525 1118 ZN, Schiphol, The Netherlands

YAESU UK LTD.

Unit 12, Sun Valley Business Park, Winnall Close
Winchester, Hampshire, SO23 0LB, U.K.

YAESU GERMANY GmbH

Am Kronberger Hang 2, D-65824 Schwalbach, Germany

YAESU HK LTD.

11th Floor Tsim Sha Tsui Centre, 66 Mody Rd.,
Tsim Sha Tsui East, Kowloon, Hong Kong

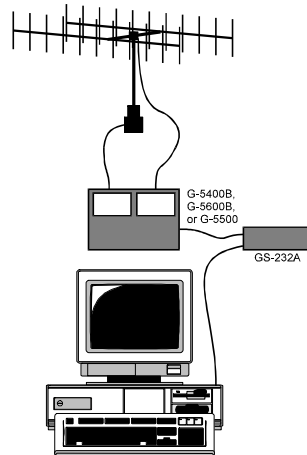
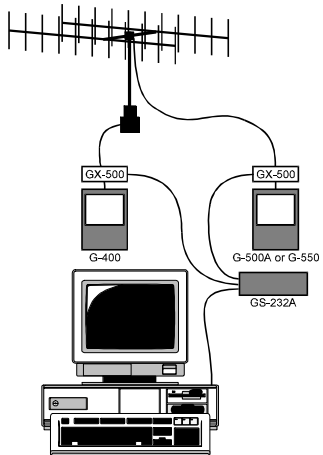
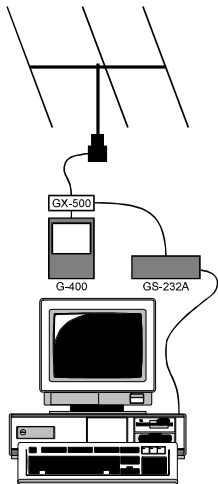
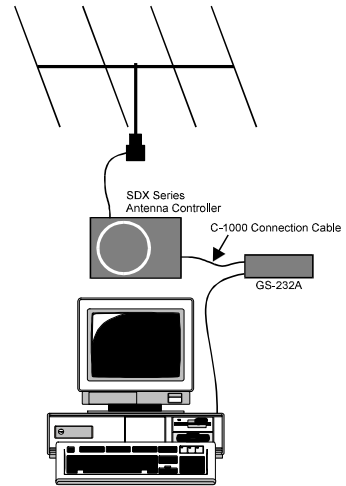
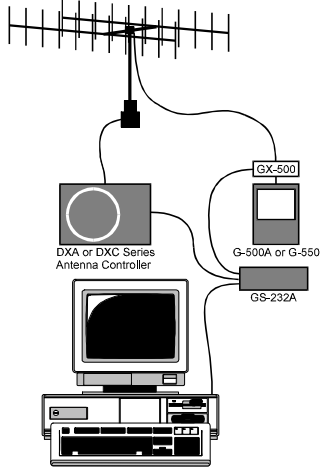
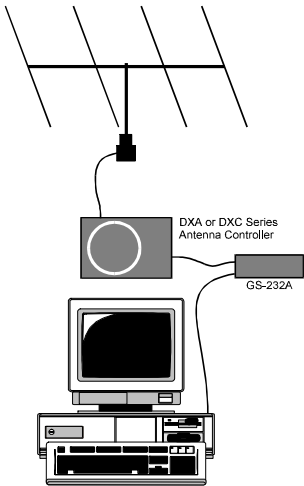

GS-232A Computer Control Interface

for Yaesu Antenna Rotators

The **GS-232A** provide digital control of most models of Yaesu antenna rotators* from the serial port of an external personal computer.

The **GS-232A** contains its own microprocessor with ROM and RAM (memory), and a 10-bit analog-to-digital (A-D) converter. The 3-wire async serial line can be configured for serial data rates from 150 to 9600 baud. The **GS-232A** has a DB-9 “male” connector for connection to the (RS-232C) COM port of your computer. Purchase or construct a “straight” type serial cable, ensuring it has the correct gender and number of pins for connection to your system.

Firmware on the **GS-232A** supports either direct keyboard control, or commands from programs written specifically to support it (software is not supplied by Yaesu). In addition to reading and setting antenna angle and rotation speed, the firmware includes clocked positioning routines to auto-

matically step the antenna through up to 3800 angles at programmable intervals, such as for tracking band openings or satellites (with an elevation rotator).

Please read this manual carefully to install the **GS-232A**. If also installing a **G-400**, **G-500A** or **G-550** with the **GX-500** Automatic Control Adapter, follow the procedures in the **GX-500** manual before installing the **GS-232A**.

- ※ **G-800DXA/G-1000DXA/G-2800DXA** Azimuth Rotator,
G-800DXC/G-1000DXC/G-2800DXC Azimuth Rotator,
G-400 Azimuth Rotator,
G-500A/G-550 Elevation Rotator,
G-5400B/G-5600B/G-5500 Az-El Rotator, and
above Azimuth and Elevation rotator combination.
G-400 Azimuth Rotator and **G-500A/G-550** Elevation Rotator requires
one **GX-500** Automatic Control Adapter each.

GENERAL

Power Requirements: DC 12 V, 110 mA
Case Size: 110 (W) x 21 (H) x 138 (D) mm
Weight (approx.): 380 g

Semiconductors

Microprocessor: HD6303XP
ROM: 27C64
RAM: 6264
A/D Converter: HD46508PA (10 bits)
Serial Comms: 3-wire Async. DCE
RS-232C voltage levels,
150 to 9600 baud, 8 data bits,
1 stop bit, no parity, no handshake

CONNECTOR PINOUTS

Serial I/O:

9-pin DB-9 connector (**RS-232C** connector)
Pin 2 - Tx Data
Pin 3 - Rx Data
Pin 5 - Signal Ground

Rotator Control:

5-pin connector (**EL** connector)
Pin 1 - UP switch (open collector)
Pin 2 - DOWN switch (open collector)
Pin 3 - analog output (0.5 - 4.5 V, four steps)
Pin 4 - analog input (0-5V elevation)
Pin 5 - analog ground

5-pin connector (**AZ** connector)
Pin 1 - RIGHT switch (open collector)
Pin 2 - LEFT switch (open collector)
Pin 3 - analog output (0.5 - 4.5 V, four steps)
Pin 4 - analog input (0-5V azimuth)
Pin 5 - analog ground

SUPPLIED ACCESSORIES

- Control cable for the Azimuth Rotator^{※1} 1 pc
("5-pin" ↔ "Min-DIN" cable)
- Control cable for the Az/EL Rotator^{※2} 1 pc
("Dual 5-pin" ↔ "DIN" cable)
- DC cable w/coaxial plug 1 pc
- Hook & loop fasteners (for mounting) 1 pc

※1: **G-5400B-G-5600B/G-5500**

※2: **G-800DXA/G-1000DXA/G-2800DXA &
G-800DXC/G-1000DXC/G-2800DXC**

AVAILABLE OPTIONS

- GX-500** (GS-232A version) Control Adapter
(Check with your dealer)
- C-1000** Connection Cable
(for **SDX** series Azimuth Rotator)
- NC-72B/C/F/U**^{※3} AC Adapter

※3: "**B**" *suffix* is for use with 117 VAC,
"**C**" *suffix* is for use with 220-240 VAC,
"**F**" *suffix* is for use with 220 VAC, or
"**U**" *suffix* is for use with 230 VAC

During installation, a personal computer with a serial port and terminal software is required to calibrate trimmers on the Controller and on the Control Interface. Any simple interactive terminal program can be used - it only has to transmit keystrokes as typed, and display characters received from the **GS-232A**.

POWER & CONTROL CONNECTIONS

DXA or DXC Series Azimuth Rotator

- ❑ Connect the supplied DC cable to a source of 12 VDC. The red lead connects to the Positive (+) DC terminal, and the black lead connects to the Negative (-) DC terminal. The **GS-232A** requires 110 mA. The supplied cable has a 500-mA fast-blow fuse. Use only the same type fuse for replacement.
- ❑ Plug the coaxial power connector into the **DC 12V** jack on the **GS-232A** rear panel.
- ❑ Connect the supplied Control cable (“5-pin” ↔ “Mini-DIN”) between the **EXT CONTROL** connector on the rotator’s controller and **AZ** connector on the rear panel of the **GS-232A** (Figure 1).

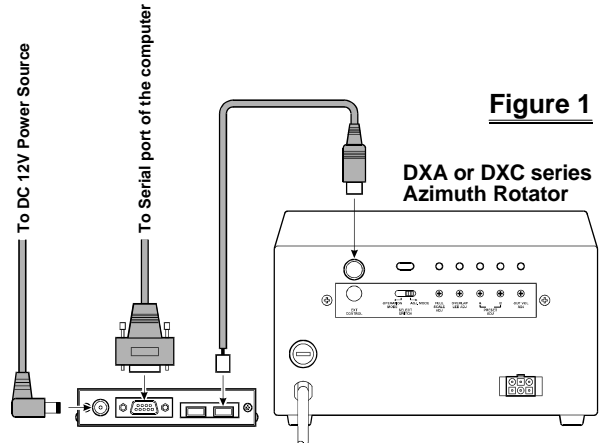

POWER & CONTROL CONNECTIONS

G-5400B/-5600B Az-EL Rotator

- ❑ Connect the supplied DC cable to a source of 12 VDC. The red lead connects to the Positive (+) DC terminal, and the black lead connects to the Negative (-) DC terminal. The **GS-232A** requires 110 mA. The supplied cable has a 500-mA fast-blow fuse. Use only the same type fuse for replacement.
- ❑ Plug the coaxial power connector into the **DC 12V** jack on the **GS-232A** rear panel.
- ❑ Connect the supplied Control cable (“Dual 5-pin” ↔ “DIN”) between the rotator’s controller and **GS-232A**. Be careful to match the “AZ” and “EL” labels on the cable with the same labels on the rear panel of the **GS-232A** (Figure 2).

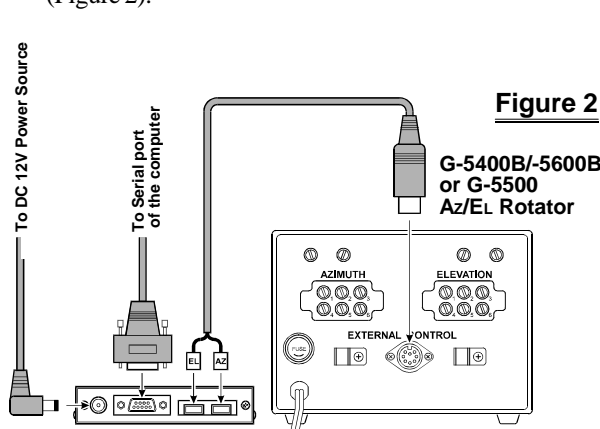

G-400/G-500 or G-400/G-550 & pair of GX-500

- ❑ Connect the supplied DC cable to a source of 12 VDC. The red lead connects to the Positive (+) DC terminal, and the black lead connects to the Negative (-) DC terminal. The **GS-232A** requires 110 mA. The supplied cable has a 500-mA fast-blow fuse. Use only the same type fuse for replacement.
- ❑ Plug the coaxial power connector into the **DC 12V** jack on the **GS-232A** rear panel.
- ❑ Connect the 5-pin to 5-pin cable (supplied with the **GX-500**; requires two sets) between the **GX-500(s)** and **GS-232A** (Figure 3).

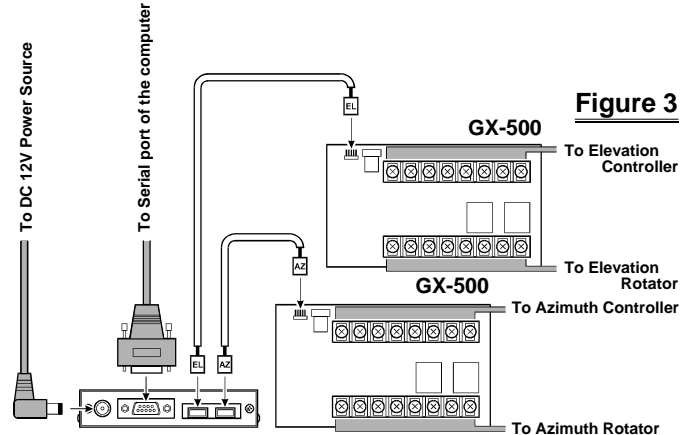

POWER & CONTROL CONNECTIONS

SDX Series Azimuth Rotator

- ❑ Prepare the optional **C-1000** Connection Cable.
- ❑ Remove the Top cover from the controller.
- ❑ Connect the 8-pin connector of the **C-1000** Connection cable to the exposed 8-pin connector located the rear left corner in the controller.
- ❑ Route the 5-pin connector of the **C-1000** Connection cable through out the rubber grommet on the rear panel of the controller, and connect it to the **AZ** connector on the rear panel of the **GS-232A** (Figure 4).
- ❑ Replace the Top Cover.
- ❑ Connect the supplied DC cable to a source of 12 VDC. The red lead connects to the Positive (+) DC terminal, and the black lead connects to the Negative (-) DC terminal. The **GS-232A** requires 110 mA. The supplied cable has a 500-mA fast-blow fuse. Use only the same type fuse for replacement.
- ❑ Plug the coaxial power connector into the **DC 12V** jack on the **GS-232A** rear panel.

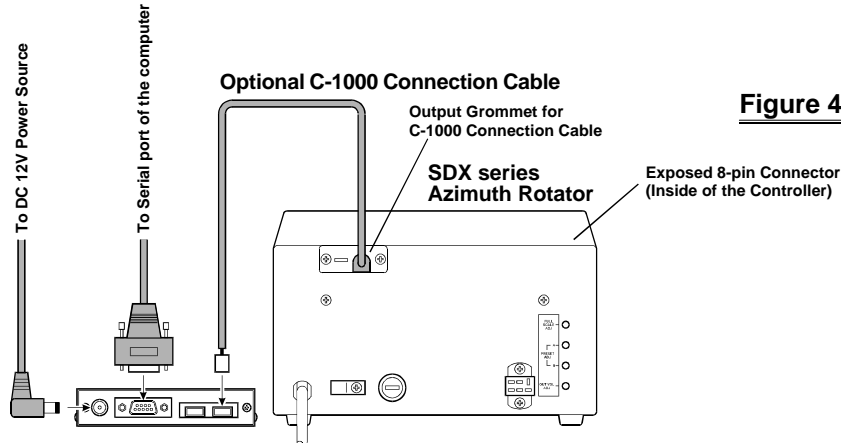

Figure 4

COMPUTER CONNECTION

- ❑ With the computer switched off, connect the RS-232C cable to the serial port of the computer, then connect the other end of your serial cable to the **RS-232C** connector on the rear panel of the **GS-232A**. Only three wires are used for serial control, so there is no hardware handshaking.
- ❑ If you are using a **G-400** Azimuth Rotator, or **G-5400B/G-5600B** Az-EL Rotator, set the **GS-232A**'s DIP switch (switch 5) to “**OFF**” position, to disable the 450° rotate operation. If you are using a other rotators (except the **G-400/G-5400B** and **G-5600B**), the **GS-232A**'s DIP switch (switch 5) is still “**ON**.”
- ❑ Select the desired data baud rate with the DIP switch bank on the **GS-232A**'s bottom case.
- ❑ The Control Interface serial data format uses 8 data bits, no parity, and one stop bit, with no handshaking. Turn on the computer, controller, and **GS-232A**, and set up your terminal program for this format and your selected data rate on the serial port to be used for rotator control.

Baud Setting DIP Switches

Baud	DIP Switch			
	1	2	3	4
150	ON	ON	ON	ON
300	OFF	ON	ON	ON
600	ON	OFF	ON	ON
1200	ON	ON	OFF	ON
2400	ON	ON	ON	OFF
4800	OFF	OFF	ON	ON
9600	ON	ON	OFF	OFF

GS-232A Rear Panel

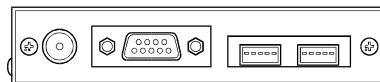

GS-232A Bottom Case

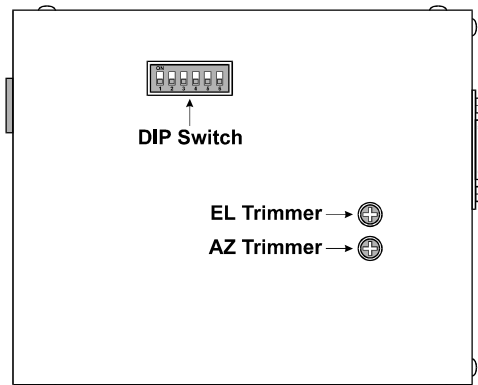

DXA/DXC/SDX SERIES AZIMUTH ROTATOR

Azimuth Offset Null

- ❑ Before calibrate the Rotator, check to see that the **GS-232A**'s DIP switch (switch 5) must be "**ON**" position.
- ❑ From the Controller panel, set the Rotator fully counter-clockwise (set to 0°).
- ❑ Press [O] → [ç] (the letter "oh", and "ENTER") on the computer keyboard to activate the azimuth calibration routine. The computer display should show **AZaaaa = bbbb** returned from the Interface Board, where **aaaa** and **bbbb** are four-digit numbers padded at the left with zeroes.
- ❑ Adjust the **AZ** trimmer (located on the bottom case of the **GS-232A**) while watching the computer display, until the four-digit numbers **aaaa** and **bbbb** are the same (the precise values are not important).
- ❑ Turn off the **GS-232A**'s **POWER** switch to exit the azimuth calibration routine, then turn on the **GS-232A**'s **POWER** switch again.

Azimuth A-D Calibration

- ❑ From the Controller panel, set the Rotator fully clockwise (to the right).
- ❑ Press [F] → [ç] ("F" and "ENTER") on the computer keyboard to activate the Control Interface's azimuth A-D converter calibration routine. The computer's display should show **+aaaa**, where **aaaa** is a four-digit number which indicates the azimuth heading in degrees.
- ❑ Adjust the **OUT VOL ADJ** potentiometer on Controller rear panel so as to get a reading of "**0450**" on the computer's display. This reading ("450 degrees") corresponds to the actual beam heading you established when you pointed the azimuth rotator to the East.
- ❑ Turn off the **GS-232A**'s **POWER** switch to exit the azimuth A-D converter calibration routine, then turn on the **GS-232A**'s **POWER** switch again.

Imprtant Note !

If your controller's indicator needle starts from the point except 0° (North) (such as the default setting of the USA version), align the starting point of the controller's indicator needle to 0° (North) before calibration.

When finish the calibration, set the controller's indicator needle to the desired point. Refer to the rotator's user manual for details regarding the indicator needle alignment.

G-400 AZIMUTH ROTATOR

Azimuth Offset Null

- ❑ Before calibrating the Rotator, check to see that the **GS-232A**'s DIP switch (switch 5) is set to the “**OFF**” position.
- ❑ From the Controller panel, set the Rotator fully counter-clockwise (set to 180°).
- ❑ Press [O] → [↵] (the letter “oh”, and “ENTER”) on the computer keyboard to activate the azimuth calibration routine. The computer display should show **AZaaaa = bbbb** returned from the Interface Board, where **aaaa** and **bbbb** are four-digit numbers padded at the left with zeroes.
- ❑ Adjust the **AZ** trimmer (located on the bottom case of the **GS-232A**) while watching the computer display, until the four-digit numbers **aaaa** and **bbbb** are the same (the precise values are not important).
- ❑ Turn off the **GS-232A**'s **POWER** switch to exit the azimuth calibration routine, then turn on the **GS-232A**'s **POWER** switch again.

Azimuth A-D Calibration

- ❑ From the Controller panel, set the Rotator fully clockwise (to the right).
- ❑ Press [F] → [↵] (“F” and “ENTER”) on the computer keyboard to activate the Control Interface's azimuth A-D converter calibration routine. The computer's display should show +**aaaa**, where **aaaa** is a four-digit number which indicates the azimuth heading in degrees.
- ❑ Adjust the **FULL SCALE ADJ** on the **GX-500** so as to get a reading of “**0180**” on the computer's display. This reading (“180 degrees”) corresponds to the actual beam heading you established when you pointed the azimuth rotator to the South (the fully clockwise setting).
- ❑ Turn off the **GS-232A**'s **POWER** switch to exit the azimuth A-D converter calibration routine, then turn on the **GS-232A**'s **POWER** switch again to turn it back on.

G-5400B/-5600B AZ-EL ROTATOR

Azimuth Offset Null

- ❑ Before calibrating the Rotator, check to see that the **GS-232A**'s DIP switch (switch 5) is set to the “**OFF**” position.
- ❑ From the Controller panel, set the Azimuth Rotator fully counter-clockwise (set to 180°).
- ❑ Press [O] → [ç] (the letter “oh”, and “ENTER”) on the computer keyboard to activate the azimuth calibration routine. The computer display should show **AZaaaa = bbbb** returned from the Interface Board, where **aaaa** and **bbbb** are four-digit numbers padded at the left with zeroes.
- ❑ Adjust the **AZ** trimmer (located on the bottom case of the **GS-232A**) while watching the computer display, until the four-digit numbers **aaaa** and **bbbb** are the same (the precise values are not important).
- ❑ Turn off the **GS-232A**'s **POWER** switch to exit the azimuth calibration routine, then turn on the **GS-232A**'s **POWER** switch again.

Azimuth A-D Calibration

- ❑ From the Controller panel, set the Azimuth Rotator fully clockwise (to the right).
- ❑ Press [F] → [ç] (“F” and “ENTER”) on the computer keyboard to activate the Control Interface's azimuth A-D converter calibration routine. The computer's display should show **+aaaa**, where **aaaa** is a four-digit number which indicates the azimuth heading in degrees.
- ❑ Adjust the **OUT VOL ADJ** potentiometer on the “**AZIMUTH**” (left) side of the Controller rear panel so as to get a reading of “**0180**” on the computer's display. This reading (“180 degrees”) corresponds to the actual beam heading you established when you pointed the azimuth rotator to the South.
- ❑ Turn off the **GS-232A**'s **POWER** switch to exit the azimuth A-D converter calibration routine, then turn on the **GS-232A**'s **POWER** switch again.

G-5400B/-5600B Az-EL ROTATOR

Elevation Offset Null

- ❑ From the Controller panel, set the Elevation Rotator to the “left” horizon (down, set to 0°).
- ❑ Press [O2] → [¿] (the letter “oh,” “2,” and “ENTER”) on the computer keyboard to activate the elevation calibration routine. The computer will return **AZaaaa = bbbb**, as in the previous procedure, *plus* **ELcccc = dddd** to the right, where **cccc** and **dddd** are four-digit numbers padded at the left with zeroes.
- ❑ Adjust the **EL** trimmer (located on the bottom case of the **GS-232A**), so as to make the numbers **cccc** and **dddd** are the same (again, the actual values are unimportant).
- ❑ Turn off the **GS-232A**’s **POWER** switch to exit the elevation calibration routine, then turn on the **GS-232A**’s **POWER** switch again to turn it back on.

Elevation A-D Calibration

- ❑ From the Controller panel, set the Elevation Rotator to full scale (180°: “right” horizon).
- ❑ Press [F2] → [¿] (F, 2, and ENTER) on the computer keyboard to activate the Control Interface’s elevation A-D converter calibration routine. The computer will display **+aaaa+eeee**, where **eeee** is a four-digit number which indicates the elevation heading in degrees. For the purposes of this alignment, you may ignore the (azimuth) **aaaa** numbers.
- ❑ Adjust the **OUT VOL ADJ** potentiometer on the “**EL-EVATION**” (right) side of the Controller rear panel so as to get a reading of “**0180**” on the computer’s display. This reading (“180 degrees”) corresponds to the actual beam heading you established when you pointed the elevation rotator to the 180° position.
- ❑ Turn off the **GS-232A**’s **POWER** switch to exit the elevation A-D converter calibration routine, then turn on the **GS-232A**’s **POWER** switch again to turn it back on.

G-5500 AZ-EL ROTATOR

Azimuth Offset Null

- ❑ Before calibrating the Rotator, check to see that the **GS-232A**'s DIP switch (switch 5) is set to the “**ON**” position.
- ❑ From the Controller panel, set the Rotator fully counter-clockwise (set to 0°).
- ❑ Press [O] → [ç] (the letter “oh”, and “**ENTER**”) on the computer keyboard to activate the azimuth calibration routine. The computer display should show **AZaaaa = bbbb** returned from the Interface Board, where **aaaa** and **bbbb** are four-digit numbers padded at the left with zeroes.
- ❑ Adjust the **AZ** trimmer (located on the bottom case of the **GS-232A**) while watching the computer display, until the four-digit numbers **aaaa** and **bbbb** are the same (the precise values are not important).
- ❑ Turn off the **GS-232A**'s **POWER** switch to exit the azimuth calibration routine, then turn on the **GS-232A**'s **POWER** switch again.

Azimuth A-D Calibration

- ❑ From the Controller panel, set the Azimuth Rotator fully clockwise (to the right).
- ❑ Press [F] → [ç] (F and **ENTER**) on the computer keyboard to activate the Control Interface's azimuth A-D converter calibration routine. The computer's display should show +**aaaa**, where **aaaa** is a four-digit number which indicates the azimuth heading in degrees.
- ❑ Adjust the **OUT VOL ADJ** potentiometer on the “**AZIMUTH**” (left) side of the Controller rear panel so as to get a reading of “**0450**” on the computer's display. This reading (“**0450**: 360 degrees + 90 degrees”) corresponds to the actual beam heading you established when you pointed the azimuth rotator fully clockwise.
- ❑ Turn off the **GS-232A**'s **POWER** switch to exit the azimuth A-D converter calibration routine, then turn on the **GS-232A**'s **POWER** switch again.

G-5500 Az-EL ROTATOR

Elevation Offset Null

- ❑ From the Controller panel, set the Elevation Rotator to the “left” horizon (down, set to 0°).
- ❑ Press [O2] → [¿] (the letter “oh,” “2,” and “ENTER”) on the computer keyboard to activate the elevation calibration routine. The computer will return **AZaaaa = bbbb**, as in the previous procedure, *plus* **ELcccc = dddd** to the right, where **cccc** and **dddd** are four-digit numbers padded at the left with zeroes.
- ❑ Adjust the **EL** trimmer (located on the bottom case of the **GS-232A**), so as to make the numbers **cccc** and **dddd** are the same (again, the actual values are unimportant).
- ❑ Turn off the **GS-232A**’s **POWER** switch to exit the elevation calibration routine, then turn on the **GS-232A**’s **POWER** switch again to turn it back on.

Elevation A-D Calibration

- ❑ From the Controller panel, set the Elevation Rotator to full scal (180°: “right” horizon).
- ❑ Press [F2] → [¿] (F, 2, and ENTER) on the computer keyboard to activate the Control Interface’s elevation A-D converter calibration routine. The computer will display **+aaaa+eeee**, where **eeee** is a four-digit number which indicates the elevation heading in degrees. For the purposes of this alignment, you may ignore the (azimuth) **aaaa** numbers.
- ❑ Adjust the **OUT VOL ADJ** potentiometer on the “**EL-EVATION**” (right) side of the Controller rear panel so as to get a reading of “**0180**” on the computer’s display. This reading (“180 degrees”) corresponds to the actual beam heading you established when you pointed the elevation rotator to the 180° position.
- ❑ Turn off the **GS-232A**’s **POWER** switch to exit the elevation A-D converter calibration routine, then turn on the **GS-232A**’s **POWER** switch again to turn it back on.

G-500 ELEVATION ROTATOR

Elevation Offset Null

- ❑ From the Controller panel, set the Elevation Rotator to the “left” horizon (down, set to 0°).
- ❑ Press [O2] → [ç] (the letter “oh,” “2,” and “ENTER”) on the computer keyboard to activate the elevation calibration routine. The computer will return **AZaaaa = bbbb**, as in the previous procedure, *plus* **ELcccc = dddd** to the right, where **cccc** and **dddd** are four-digit numbers padded at the left with zeroes.
- ❑ Adjust the **EL** trimmer (located on the bottom case of the **GS-232A**), so as to make the numbers **cccc** and **dddd** are the same (again, the actual values are unimportant).
- ❑ Turn off the **GS-232A**’s **POWER** switch to exit the elevation calibration routine, then turn on the **GS-232A**’s **POWER** switch again to turn it back on.

Elevation A-D Calibration

- ❑ From the Controller panel, set the Elevation Rotator to full scale (180°: “right” horizon).
- ❑ Press [F2] → [ç] (F, 2, and ENTER) on the computer keyboard to activate the Control Interface’s elevation A-D converter calibration routine. The computer will display **+aaaa+eeee**, where **eeee** is a four-digit number which indicates the elevation heading in degrees. For the purposes of this alignment, you may ignore the (azimuth) **aaaa** numbers.
- ❑ Adjust the **OUT VOL ADJ** potentiometer on the **GX-500** so as to get a reading of “**0180**” on the computer’s display. This reading (“180 degrees”) corresponds to the actual beam heading you established when you pointed the elevation rotator to the 180° position.
- ❑ Turn off the **GS-232A**’s **POWER** switch to exit the elevation A-D converter calibration routine, then turn on the **GS-232A**’s **POWER** switch again to turn it back on.

GENERAL

If you wish, you can mount the **GS-232A** on top of your Rotator Controller using the two supplied hook-and-loop fastener strips. Just remove the backing from one side of each strip, and press into place on the bottom of the **GS-232A**. Then remove the backing from the other side, and press the **GS-232A** into place on the Controller.

After installation and calibration, the Control Interface can accept commands entered directly from the keyboard, or from a program written specifically to support it (not supplied by Yaesu). For brief summaries of the commands recognized by the Control Interface, press [H] → [⏏] for a list of azimuth commands, or [H2] → [⏏] for elevations commands. Keep in mind that all commands require that the **ENTER** key be pressed after the command letter (or “ODh” be sent by a control program), although we will not repeat this when discussing the commands. Also note that any command letter may be sent in either upper or lower case. The info screens shown on the next page will be returned by the Control Interface.

Most commands have two versions: one for azimuth, and one for elevation. Commands are not echoed by the Control Interface, but a carriage return character (“ODh”) is returned after every command, and also a line feed character (“OAh”) if the command invoked returned data. Invalid commands cause “? >” to be returned and the input buffer cleared. Note that all angles are in degrees, beginning with zero at the most counterclockwise azimuth (or horizontal elevation). Angles sent to the Control Interface must be 3 digits long (left-zero-padded), and angles returned will, in some cases, be 4 digits long with a leading “+0.”

COMMAND LIST

In the following command descriptions, the elevation version of each command, where there is one, is shown in parentheses (but don't type the parentheses). Remember that elevation commands require the **G-5400B**, **G-5600B** or **G-5500** Az/EL Rotators, or the **GX-500** adapter and the **G-500** or **G-550** Elevation Rotator.

O (O2)

Offset calibration for internal AZ (EL) trimmer potentiometer: preset rotator manually fully counter-clockwise, send command, and adjust trimmer on Control Interface until returned values are equal. Turn off the **GS-232A**'s **POWER** switch to store settings.

H (H2)

Returns list of commands (see page 19).

F (F2)

Full Scale Calibration: preset rotator manually to full scale, send command, adjust **OUT VOL ADJ** trimmer on rear of controller (or **GX-500** elevation adapter) until the returned data is "+0180 or +0450" ("+0nnn+0180" for elevation). Turn off the **GS-232A**'s **POWER** switch to save new settings.

R (U)

Start turning the rotator to the right (up)

L (D)

Start turning the rotator to the left (down).

A (E)

Stop azimuth (elevation) rotation.

S

Stop: cancel current command before completion.

C (B)

Return current azimuth (elevation) angle in the form "+0nnn" degrees.

C2

Return azimuth and elevation ("+0aaa+0eee", where *aaa* = azimuth, *eee* = elevation).

Xn

Select azimuth rotator turning speed, where *n* = 1 (slowest) to 4 (fastest). This command can be issued during rotation, and takes effect immediately. There is no equivalent for elevation.

COMMAND LIST

Maaa

Turn to *aaa* degrees azimuth, where *aaa* is three digits between “000” and “360 or 450: vary according to controller type.” Rotation starts.

Msss aaa bbb ccc

This command, together with the [T] command, provides automatic, timed tracking of moving objects or propagation by the Control Interface itself. This command stores the time value *sss* seconds to wait between stepping from azimuth *aaa* to *bbb*, and then to *ccc*, etc. (from “2” to as many as “3800” angles may be stored with one command).

Note that this command is completely different than the [T] command with only one parameter: when multiple parameters are present, the first one is interpreted by the Control Interface as the rotation interval *sss*, not an angle. Valid ranges are “001” to “999” for *sss*, and “000” to “360 or 450: vary according to controller type” for the angles. When this command is sent, the parameters are stored in the Control Interface’s RAM, and the rotator turns to angle *aaa* and waits for a subsequent [T] command to begin the actual stepping. All numbers must be 3 digits, space-separated. Stored values remain in effect until another [M] command is issued (this may have no parameters, in which case the “? >” error prompt is returned, but memories are still cleared), or until the controller is turned off or by toggling the **GS-232A** off and on.

T

See the [M] (above) and the [W] (below) command. Start automatic stepping routine (both azimuth and elevation): turn rotator to next sequentially memorized azimuth (or az-el pair, for the [W] command), wait *sss* seconds, and turn to next angle (or pair), etc. This command works only if a long-form [M] or [W] has been issued since power-up or the last reset.

N

Return serial number of currently selected memorized point [*nnnn*], and total number of memorized points [*mmmm*], in the form +*nnnn*+*mmmm*. Must be preceded by either a long-form [M] or [W], and a T command. Used only during stepping (see [T] command).

The meaning of a “point” in this command following an [M] command is only an azimuth angle, so in this case *nnnn* and *mmmm* can range up to “3800” (the limit of available RAM in the Control Interface). However, when elevation is involved, a “point” following a [W] command is represented by both an azimuth and an elevation angle, in which case *nnnn* and *mmmm* can range up to only “1900,” since each “point” is a pair of angles.

COMMAND LIST

Elevation Control Commands

These commands are only for az-el operation. Note that an azimuth angle must always be supplied when changing elevation, and that a setting point consists of a pair of angles.

Waaa eee

Turn to *aaa* degrees azimuth and *eee* degrees elevation, where *aaa* is three digits between “000” and “360 or 450: vary according to controller type,” and *eee* is three digits between “000” and “180.” Rotators respond immediately.

Wsss aaa eee aaa sss ...

This command is similar to the [M] command: the first parameter is a time interval, and succeeding parameters are angles. With this command, however, angles are in azimuth-elevation pairs, each pair representing one antenna location. At most “1900” pairs can be sent and stored in the Control Interface. As with the other commands, the time interval range is limited to “001” to “999” (seconds), azimuth to “000” to “360 or 450: vary according to controller type,” and elevation to “000” to “180.”

When this command is sent, the rotators turn to the first *aaa* azimuth parameter and the first *eee* elevation parameter, and wait for a subsequent [T] command to begin the actual stepping (to the next azimuth-elevation pair). Stored values remain in effect until another [W] command is issued (this may have no parameters, in which case the “? >” error prompt is returned, but memories are still cleared), or until the controller is turned off or by toggling the **GS-232A** off and on.

COMMAND LIST

Returned by [H] Command:

----- COMMAND LIST 1 -----

- R** Clockwise Rotation
- L** Counter Clockwise Rotation
- A** CW/CCW Rotation Stop
- C** Antenna Direction Value
- M** Antenna Direction Setting. MXXX
- M** Time Interval Direction Setting.
MTTT XXX XXX XXX ---
(TTT = Step value)
(XXX = Horizontal Angle)
- T** Start Command in the time interval direction setting mode.
- N** Total number of setting angles in "M" mode and traced number of all datas (setting angles)
- X 1** Rotation Speed 1 (Horizontal) Low
- X 2** Rotation Speed 2 (Horizontal) Middle 1
- X 3** Rotation Speed 3 (Horizontal) Middle 2
- X 4** Rotation Speed 4 (Horizontal) High
- S** All Stop
- O** Offset Calibration
- F** Full Scale Calibration

Returned by [H2] Command:

----- HELP COMMAND 2 -----

- U** UP Direction Rotation
- D** DOWN Direction Rotation
- E** UP/DOWN Direction Rotation Stop
- C 2** Antenna Direction Value
- W** Antenna Direction Setting.
WXXX YYY
- W** Time Interval Direction Setting.
WTTT XXX YYY XXX YYY ---
(TTT = Step value)
(XXX = Horizontal Angle)
(YYY = Elevation Angle)
- T** Start Command in the time interval direction setting mode.
- N** Total number of setting angle in "W" mode and traced number of all datas (setting angles)
- S** All Stop
- O 2** Offset Calibration
- F 2** Full Scale Calibration
- B** Elevation Antenna Direction Value

NOTE

20

YAESU

Copyright 2000
Yaesu Musen Co., Ltd.
All rights reserved.



E A A 1 4 X 1 0 0

No portion of this manual
may be reproduced
without the permission of
Yaesu Musen Co., Ltd.

Printed in Japan